

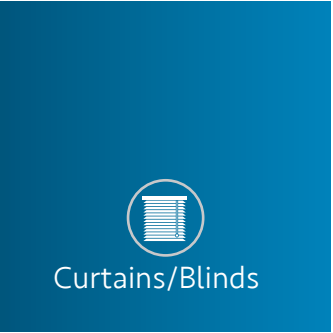

INDUSTRIAL & COMMERCIAL BUILDING SOLUTIONS

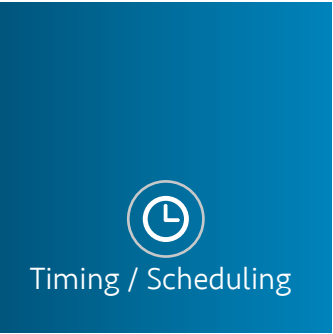

INDEX

About SOLUTION	3
Topology	6
Products	7
Certificates	28
References	30





EAE KNX Commercial and Industrial Building Solutions are flexible and extendable to fulfil all the requirements and expectations of customers.

EAE Technology products are designed with manufacturer-independent protocols such as KNX, making extensions of the system possible with any other KNX manufactured products.

Movement and Daylight Sensor Control

The lighting and air conditioning devices are controlled by means of sensors sensitive to movement.

Timing, Schedule Management

Automatic control of devices is ensured by means of daily, weekly monthly or custom developed schedules.

Daylight Harvesting

Both indoor and outdoor lighting requirements can be managed by means of daylight related controls.

Zone Control On/Off & Dim

Standard lighting fixtures can now be managed in line/group basis by means of switching modules.

HVAC Control: VRF, VRV, Fancoil, Air Conditioning etc...

Heating/cooling monitoring and management is in your hands thanks to the fancoil control units.





Central Monitoring / Control

The monitoring and control functions are managed centrally in a convenient manner and with speed over architectural visuals.

DALI Lighting Control

You can monitor and manage your lighting fixtures of dimmable and addressable nature.

Shutter-Blind Control

You can control your curtains/blinds and/or sunshades according to the daylight, time of the day over a central monitoring system.

Emergency Lighting Reporting

Reports the battery testing and error status of the emergency lighting fixtures available in the facility.

Alarm & Warning Reports

Provides instant warnings over SMS and e-mail and saves time in special situations where the establishment is required to respond promptly.

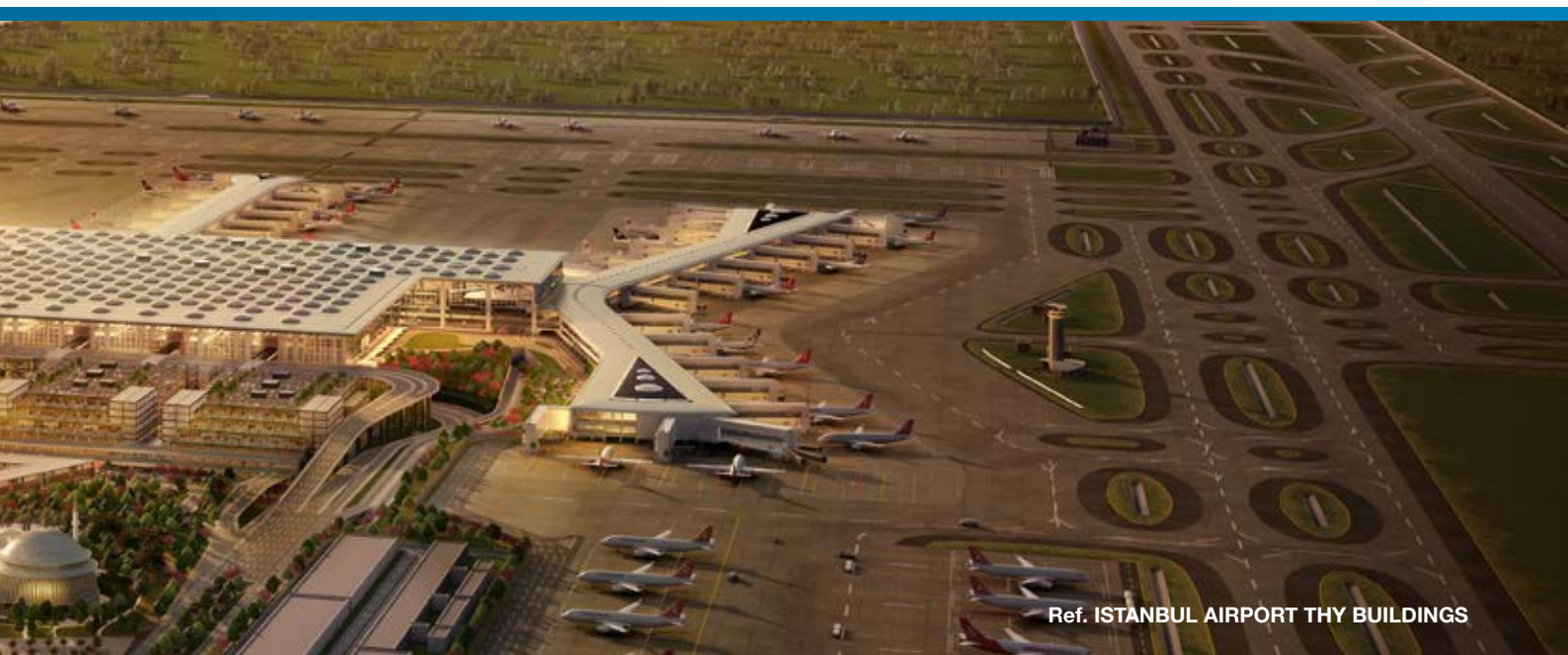

Ref. ISTANBUL AIRPORT THY BUILDINGS

TOPOLOGY

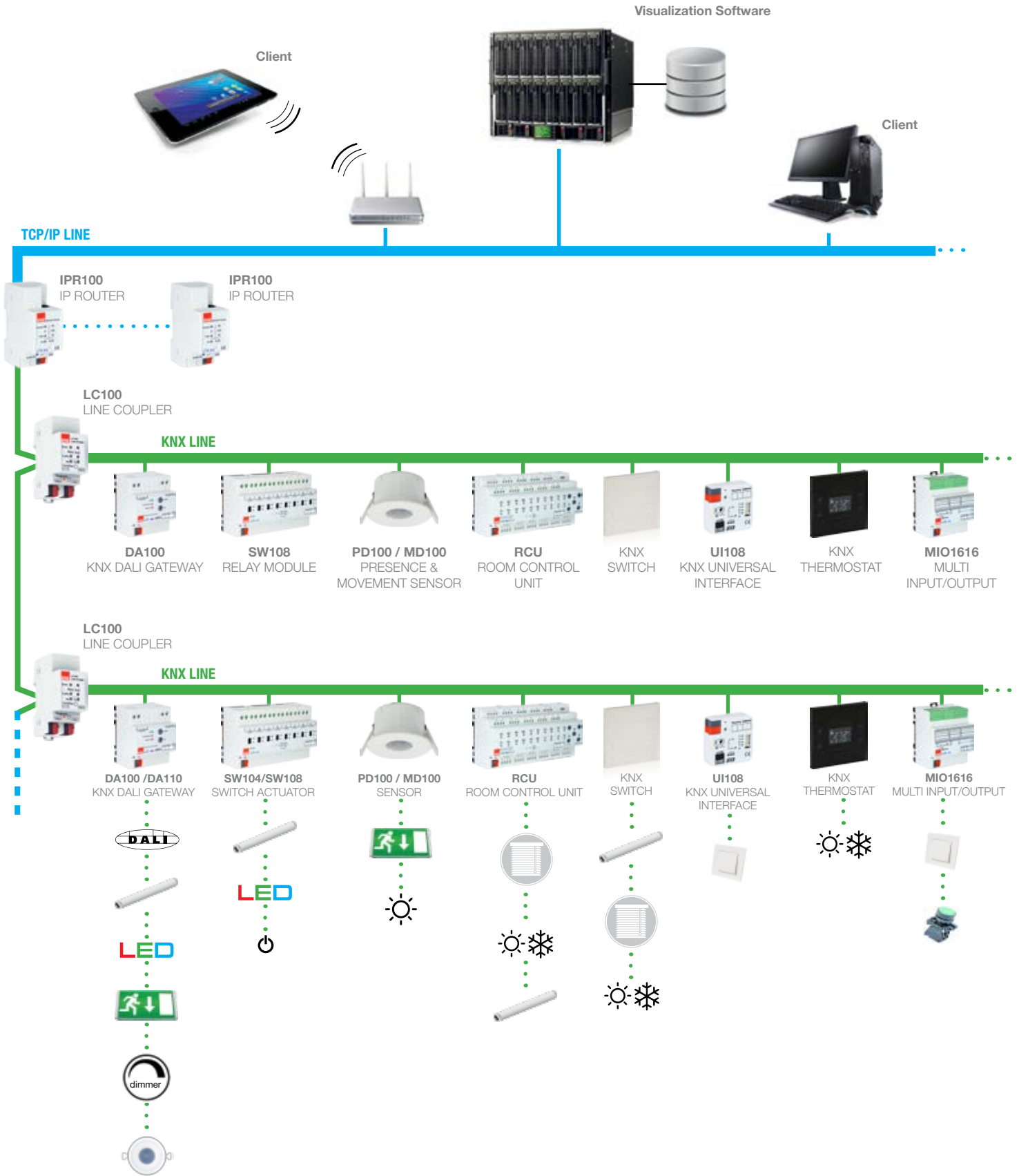



PRODUCTS

- ▶ **VALESA** TOUCH PANEL
- ▶ **PD100 / MD100** MOVEMENT AND DAYLIGHT SENSOR
- ▶ **KNX** SWITCHES, THERMOSTATS and FRAMES
- ▶ **RCU2018 / RCU2000 / RCU0800 / RCU0808**
RCU1200 / RCU1212 ROOM CONTROL UNIT
- ▶ **DA100 / DA110** KNX DALI GATEWAY
- ▶ **SW104 / SW108** SWITCH ACTUATOR
- ▶ **SD110** 0-10V / 1-10V DIM ACTUATOR
- ▶ **UD105** UNIVERSAL DIMMER
- ▶ **UI108** KNX UNIVERSAL INTERFACE MODULE
- ▶ **MIO1616** MULTI INPUT/OUTPUT
- ▶ **IPR100/IPI100** KNX IP ROUTER
- ▶ **LC100** LINE COUPLER
- ▶ **PSU320/640** POWER SUPPLY
- ▶ **CD100** CORRIDOR DETECTOR
- ▶ **MIG100** MITSUBISHI CLIMA GATEWAY





With Valesa panel, family members of all ages can easily control lighting, heating-cooling, shutter-blind devices, activate burglar alarm, monitor cameras and use intercom to converse with incoming guests. You can easily call a taxi cab, valet or make SPA reservation easily by using integrated concierge services.

Helping to experience comfort in your home, Valesa panel technology is designed to meet all your needs from a single interface. In addition to adding elegance to chosen aesthetic of your spaces with a touch of design, Valesa panel will also become an essential part of your home.



Reception

IP based communications by reception staff



11.6" Valesa

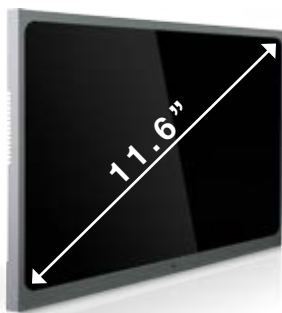

- Mustang Gray
- Anthracite
- Pearl White

9" Valesa



- Mustang Gray
- Anthracite
- Pearl White

11.6" Valesa Technical Specifications

Processor	ARM 64-bit Quad-Core CPU
Display	1366 x 768 pixels resolution
Memory	1 GB DDR3L
Graphics Processor	Intel(R) HD Graphics 400 @ 500 MHz
Audio	2 x 3W speaker Noise canceling microphone
OS	Application-oriented customized Linux 4.9.30
Inputs	KNX 2 x 100Mbit (Cat5e) Ethernet 8 x dry contact input* RS-232 (Optional) RS-485 (Optional)
Output	6 x 6A (Optional)
Power	12-24V DC

* High voltage and overcurrent protection, insulated

11.6" Valesa Dimensions

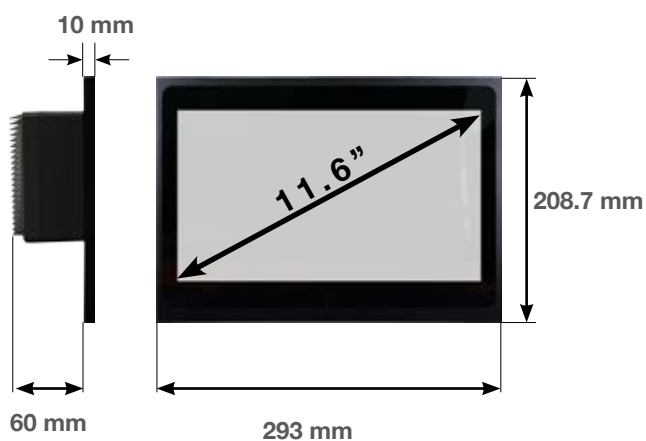

Wall Cutting Dimensions : 186 x 142 mm

9" Valesa Dimensions

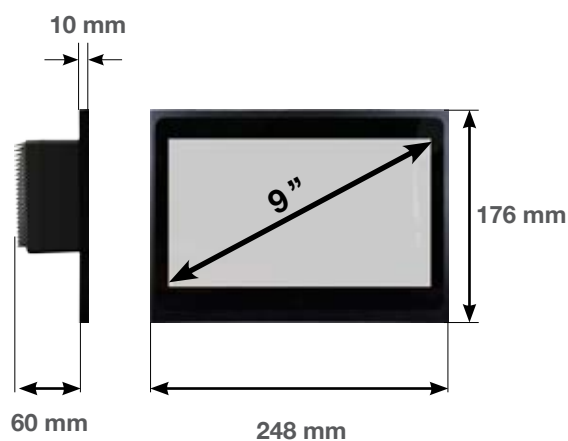

PD100 / MD100

EAE KNX SENSOR

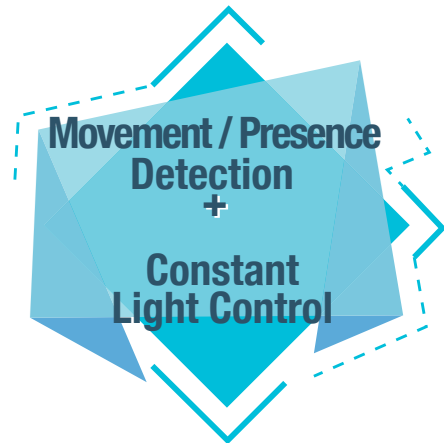

General Specifications

- PD100 movement sensor is ideal for indoor use such as in medium and large scale office spaces, conference halls, corridors, classrooms, parking garages. It comes in two models; flush-mounted and surface-mounted. It can detect movements at 2.5 m assembly height in a diameter of 9 m.
- Thanks to the integrated light level sensor and movement sensor it can implement fixed light function depending on the presence of a movement. The current level of ambient light is compared to the lux level desired to ensure the appropriate level of illumination in the area concerned.
- By means of the corridor function, different levels of brightness can be arranged for the states of; "Movement", "After Movement", and "No Movement". The duration of light projection after the movement can be adjusted by the user.
- Other than the control of the lighting level, it would also be possible to control the air conditioning and ventilation through HVAC.
- It is possible to send periodic information of different communication object by means of the independent movement monitoring channel. This could be used in movement monitoring applications.
- It can operate in parallel connection with other sensors either on standalone or master-slave basis depending on application requirements.
- Based on the state of use of the external controls (button, switch, other sensors, etc.) full or semi automatic operating modes could be set-up.
- Test and calibration modes are convenient during installation.
- Does not need external feed as it receives its feed over KNX line

Dimensions (mm)

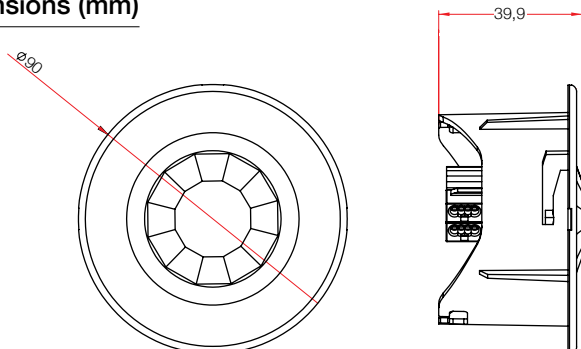

Technical Information

Protection Type	IP 20	EN 60529
Safety Class	II	EN 61140
Feed	Voltage range Current consumption	21 - 30V DC, KNX Hattı ile < 10mA
Application areas		Indoors
Sensor Type		Passive infrared
Installation	Location Recommended height	Ceiling 2.5 m – 4m
Detection	PD100 Diameter (at 2.5 m height) MD100 Diameter (at 2.5 m height) Angle Light Level	6.5 m diameter (tangent walk) 9 m diameter (tangent walk) 3600 100 – 1000 lux
Additional Channels		Illumination level, movement channel, HVAC ch.
Parallel Operation		Master/Master, Slave/Master
Operating Elements	LED (Red) and button	Used to program the device
Operating Temperature	Operation Storage Transportation	- 5°C +45°C -25°C +55°C -25°C +70°C
Dimensions		42.5 x 42,5 x 12 mm
Weight	0.06 kg	
Ceiling section dimension	75 mm diameter	

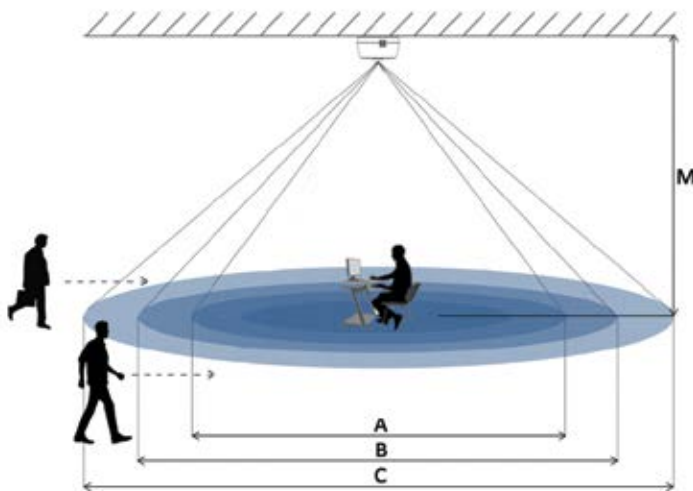

A: Area of detection according to a seated person
 B: Area of detection upon direct approach on feet
 C: Area of detection upon tangent approach on feet

PD100 Presence and Daylight Sensor

PD100	A	B	C
4,0 m	7,8 m	7 m	12 m
3,5 m	7,3 m	6,5 m	10 m
3,0 m	6 m	6 m	8 m
2,5 m	5 m	5 m	6 m

MD100 Movement and Daylight Sensor

MD100	B	C
5,0 m	9 m	15 m
4,0 m	8 m	13 m
3,5 m	7,5 m	12 m
3,0 m	7 m	10,5 m
2,5 m	6,5 m	9 m

Ordering Information

Product Name	Product Code	Ordering Code	Package Information
EAE KNX Presence and Daylight Sensor (Flush mounted)	SMP PD100 EAE F-KNX	48018	1 pcs.
EAE KNX Movement and Daylight Sensor (Flush mounted)	SMP MD100 EAE F-KNX	48019	1 pcs.

SWITCHES

oria
push button



rosa
touch button



General Specifications

- Can be configured with ETS4 / ETS5.
- Plastic push-button and metal touch-button switch series
- Wide collection option up to 6 Folds
- Product options with and without notification LED
- Optionally, icon is available.
- Different color options (see: KNX Smart home catalog)
- Easy installation to 60x60 mm standard switch junctions
- Channels are identical, each with the following functions;
 - Switching,
 - Dimming,
 - Value,
 - Scene Control,
 - Shutter/Blind Control,
 - Status notification LED

Technical Information

Protection Type	IP 20	EN 60529
Safety Class	II	EN 61140
Feed	Voltage range	21-30V DC, Over EIB/KNX data line
	Feed voltage	15 mA
	Power consumption	15 mA x 30V
Connections	EIB/KNX	Feeds through EIB/KNX data line
Operation LEDs	Programming LED for each fold	To define physical address 1 to 5 RGB LED
Button Operation Life	100.00	
Operation Temperature	Operation	-5° C + 45° C
	Storage	-25° C + 55° C
	Transportation	-25° C + 70° C
CE	Pursuant to EMC Guided and Low Voltage Regulation	

Dimensions (mm)

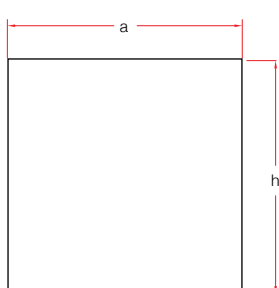

oria

Type	a	b	h
Single	90	9	90
1 Fold	90	9	90
2 Fold	90	9	90
3 Fold	90	9	90
4 Fold	90	9	90
5 Fold	90	9	111,5
6 Fold	90	9	133



rosa

Type	a	b	h
Single	80	8,5	80
1 Fold	80	8,5	80
2 Fold	80	8,5	80
3 Fold	80	8,5	80
4 Fold	80	8,5	107,3
5 Fold	80	8,5	134,7

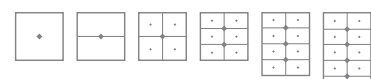

THERMOSTATS

oria
push button



rosa
touch button



General Specifications

- Can be configured with ETS4 / ETS5.
- Plastic push-button and metal touch-button switch series
- Temperature control via digital LCD
- Adjustable fan speed (1, 2, 3, Automatic)
- Fully automated operation feature (warm-cold transition)
- Control of all HVAC units including VRF-VRV and air conditioning devices
- PI proportional, PI on-off (PWM), On/Off, Fan coil, Split unit controls
- Easy installation to 60x60 mm standard switch junction
- Programmable buttons can be programmed for various functions. (2 dependent or 4 independent)
 - Switching,
 - Value,
 - Dimming,
 - Scene Control,
 - Wide collection option up to 4 Folds
 - Internal temperature sensor (°C/ °F)
 - Multiple operation modes (Comfort, Night, Out, Off)
 - Shutter/Blind Control,
 - Status notification LED

Technical Information

Protection Type	IP 20	EN 60529
Safety Class	II	EN 61140
Feed	Voltage range	21-30V DC, Over EIB/KNX data line
	Feed voltage	20 mA
	Power consumption	20 mA x 30V
Operation LEDs	Programming LED for each fold	To define physical address 1 to 5 RGB LED
Button Operation Life	100.00	
Operation Temperature	Operation	-5° C + 45° C
	Storage	-25° C + 55° C
	Transportation	-25° C + 70° C
CE	Pursuant to EMC Guided and Low Voltage Regulation	

Dimensions (mm)

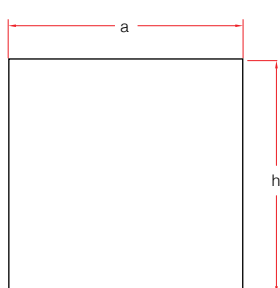

oria

Type	a	b	h
2 Fold Thermostat	90	9	90
3 Fold Thermostat	90	9	111,5
4 Fold Thermostat	90	9	133



rosa

Type	a	b	h
2 Fold Thermostat	80	8,5	80
3 Fold Thermostat	80	8,5	107,3
4 Fold Thermostat	80	8,5	134,7

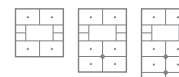

RCU2018 / RCU2000 / RCU0808 / RCU0800 / RCU1212 / RCU1200

EAE KNX-ROOM CONTROL UNIT

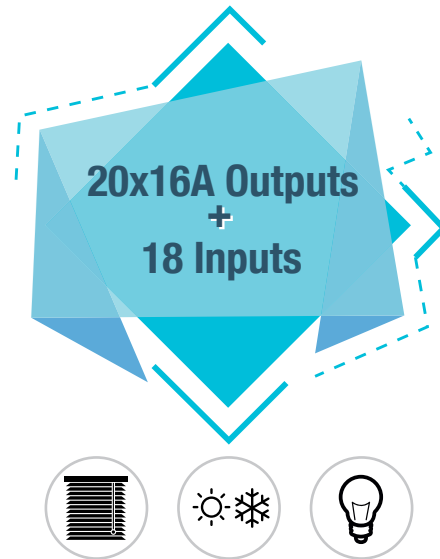

General Specifications

- Room Control Unit RCU2018 is designed as an all in one product for different room layouts such as apartments, hotel rooms, hospitals and residences.

- Room Control Unit covers all requirements of the electrical installation of room applications and offers following functions in a one product.

- Switching lighting
- Switching loads
- Controlling AC/DC blinds
- Controlling fan coils (2 & 3 point valve)
- Dry contact inputs

- RCU2018 has 20x16A relay outputs. These outputs are grouped as 5 independent output channels. Each channel can be configured to have different modes of operation as follows,

- Switching output x4
- AC Blind x2
- DC Blind x1
- 2 Point valve x2
- 3 point valve x1

- Suitable for switching resistive, capacitive and inductive loads as well as fluorescent lamp loads according to EN 60 669. As a switch output device provides following function list,

- Staircase
- External logic
- Internal logic
- Priority
- Threshold
- Operating hour
- Sweep

- Device has 18 independent input channels. Input channel operates as universal interface with following functions,

- Switch / push button input
- Dimmer control
- Control of shutter/blinds
- Value sending
- Scene control
- Counter for count pulse

- Manual control is possible for each channel through the built-in button panel.

- 220V auxiliary power is not required.

Dimensions (mm)

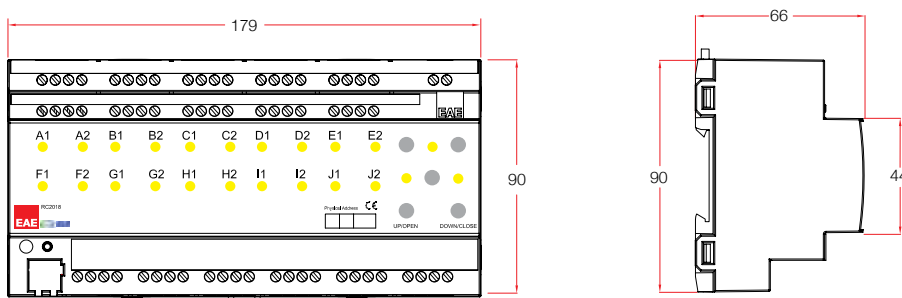

Technical Information

Protection Type	IP 20	EN 60529	
Safety Class	II	EN 61140	
Power supply	Voltage	21V... 30V DC, SELV	
	Current consumption	< 10 mA	
External supply	-	-	
Connections	Screw terminals	0,05...4 mm ² solid and stranded wire 0,05...2,5 mm ² stranded wire with ferrule	
	Max tightening torque	0.8 Nm	
	KNX	Bus connect terminal	
Output	Number	20 output	
	Switching voltage	250V AC; 50/60 Hz	
	Switching capacity 250V AC	16A / AC 1	
	Maximum switching power	4000 VA	
	Mechanical life	> 1 x 10 ⁶	
Type of contact	potential-free, bistable		
Input	Number	18 binary inputs	
	Scanning voltage	32V pulsed	
	Current	0.1 mA	
	Cable length	<300 m	
Installation	35mm mounting rail	EN 60 715	
Operating elements	LED (red) and button	For physical address	
Temperature range	Ambient	-5° C + 45° C	
	Storage	-25° C + 55° C	
Humidity	max. air humidity	85 % no moisture condensation	
Dimensions		66 x W x 90mm	
	Width W in mm	180 mm	
	Width W in units (18 mm modules)	10 modules	
Weight	0.65 kg		
Box	Plastic, polycarbonate, colour grey		
CE	In accordance with the EMC guideline and low voltage		
Application program	Communication objects	Number of addresses(max)	Number of assignments(max)
	254	255	255

Ordering Information

Product Name	Product Code	Ordering Code	Package Information
EAE Knx Room Control Unit 20Ch, Fancoil, Switch, Blind Actuator	SMP RCU2018 EAE S-KNX	48024	1 unit

DA100

EAE KNX-DALI GATEWAY (16 Group Control)



General Specifications

- Device parameters can be configured via ETS3/ETS4/ETS5.
- DA100 KNX-DALI interface operates as a DALI-IEC 62386 standard compliant gateway between KNX line and DALI. DALI line power supply is available as integrated to the device.
- Maximum of 64 DALI devices can be connected to DALI outlet (electronic ballast, LED drive, ECK, sensor).
- The operations such as addressing, grouping, etc. of DALI devices are performed by means of Windows based DALI commissioning software (EAE DALI Commissioning Tool).
- DA100 provides the means for the recording of 16 DALI Group controls and 64 different lighting scenes.
- Each DALI group could be operated with fixed light, corridor and sequence functions.
- The functional and battery testing calendars are loaded on to DALI compliant emergency lighting fixtures to ensure that periodic tests are conducted. The results of the tests conducted are relayed over KNX line.
- DA100 can use up to 8 DALI sensors. Sensors can operate the corridor and fixed lighting functions over DALI Groups. It is possible to relay movement information and brightness value to KNX line.
- The error status of DALI devices can be received by means of different KNX communication objects on device and group basis.
- Intersecting DALI groups can be created.

Dimensions (mm)

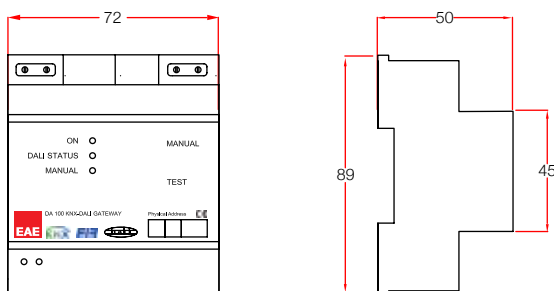

Technical Information

Protection Type	IP 20	EN 60529	
Safety Class	II	EN 61140	
KNX Feed	Voltage range	21 - 30V DC, SELV	
	Current consumption	< 10mA	
External Feed	Voltage range	85 - 300V AC @ 50-60Hz	
	Power Consumption	≤ 8W	
	Current consumption	100mA @ 85V AC	
DALI Feed	Voltage range	16V DC ~	
	Current consumption	≤ 200mA	
Connections	Screw terminal	0,05 - 2,5mm ² single core cable 0,03 - 1,5mm ² multi core cable	
	Maximum Torque	0.5Nm	
	KNX Terminal	Red-Black KNX Line Connection	
Output	Number of DALI devices	Maximum 64 (max. 8 sensors)	
	Cable lengths	1.5 mm ² ≤ 300 m 0.75 mm ² ≤ 150 m 0.5 mm ² ≤ 100 m	
Configuration	35 mm mounting rail	EN 60715	
Operating Elements	Programming LED and button	Used for physical address	
	Green LED ⁽⁷⁾	Problem-free KNX line	
	Yellow LED ⁽⁸⁾	First start-up (fast flashing) Device failure on DALI Line (slow flashing) Power supply fault (continuously on)	
	Red LED ⁽⁹⁾	Manual control active	
	Manual Button ⁽¹⁰⁾	Entire DALI line on-off, dimming (when manual control is active)	
	Test Button ⁽¹¹⁾		
Operating Temperature	Operation	5°C +45°C	
	Storage	-25°C +55°C	
	Transportation	-25°C +70°C	
Humidity	Maximum humidity	95% no condensation	
Dimensions		70 x G x 91mm	
	Width W (mm)	69mm	
	Width W (unit)	4 modules (18 mm module)	
Weight		0.15 kg	
Box	Plastic, Polycarbon, Grey		
CE	Pursuant to EMC Guide and Low Current Regulation		
Application Program	Communication objects 249	Max. Group Addresses 254	Max. no. of matches 255

Ordering Information

Product Name	Product Code	Ordering Code	Package Information
DA100 EAE Knx Dali Gateway V2	SMP DA100 EAE S-KNX	48017	1 unit

DA110

EAE KNX-DALI GATEWAY (Individual DALI Load Control)



General Specifications

- DA110 KNX-DALI interface operates as a DALI-IEC 62386 standard compliant gateway between KNX line and DALI. DALI line power supply is available as integrated to the device.
- Maximum of 64 DALI devices can be connected to DALI outlet (electronic ballast, LED drive, ECK, sensor).
- The operations such as addressing, grouping, etc. of DALI devices are performed by means of Windows based DALI commissioning software (EAE DALI Commissioning Tool).
- DA110 provides the means for the recording of 16 DALI Group controls and 64 different lighting scenes.
- The functional and battery testing calendars are loaded on to DALI compliant emergency lighting fixtures to ensure that periodic tests are conducted. The results of the tests conducted are relayed over KNX line.
- The error status of DALI devices can be received by means of different KNX communication objects on device and group basis.

Dimensions (mm)

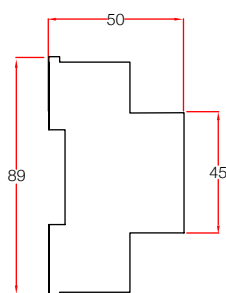
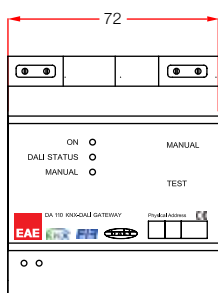

Technical Information

Protection Type	IP 20	EN 60529	
Safety Class	II	EN 61140	
KNX Feed	Voltage range	21 - 30V DC, SELV	
	Current consumption	< 10mA	
External Feed	Voltage range	85 - 300V AC @ 50-60Hz	
	Power Consumption	≤ 8W	
	Current consumption	100mA @ 85V AC	
DALI Feed	Voltage range	16V DC ~	
	Current consumption	≤ 200mA	
Connections	Screw terminal	0,05 - 2,5mm ² single core cable 0,03 - 1,5mm ² multi core cable	
	Maximum Torque	0.5Nm	
	KNX Terminal	Red-Black KNX Line Connection	
Output	Number of DALI devices	Maximum 64 (max. 8 sensors)	
	Cable lengths	1.5 mm ² ≤ 300 m 0.75 mm ² ≤ 150 m 0.5 mm ² ≤ 100 m	
Configuration	35 mm mounting rail	EN 60715	
Operating Elements	Programming LED and button	Used for physical address	
	Green LED ⁽⁷⁾	Problem-free KNX line	
	Yellow LED ⁽⁸⁾	First start-up (fast flashing) Device failure on DALI Line (slow flashing) Power supply fault (continuously on)	
	Red LED ⁽⁹⁾	Manual control active	
	Manual Button ⁽¹⁰⁾	Entire DALI line on-off, dimming (when manual control is active)	
	Test Button ⁽¹¹⁾		
Operating Temperature	Operation	5°C +45°C	
	Storage	-25°C +55°C	
	Transportation	-25°C +70°C	
Humidity	Maximum humidity	95% no condensation	
Dimensions		70 x G x 91mm	
	Width W (mm)	69mm	
	Width W (unit)	4 modules (18 mm module)	
Weight		0.15 kg	
Box	Plastic, Polycarbon, Grey		
CE	Pursuant to EMC Guide and Low Current Regulation		
Application Program	Communication objects	Max. Group Addresses	Max. no. of matches
	249	254	255

SW104/SW108

EAE KNX SWITCH ACTUATOR

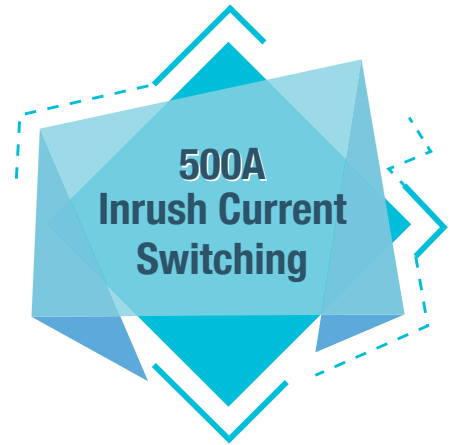

General Specifications

- Possesses 8 independent channels that could be configured by means of ETS3/ETS4/ETS5.
- In addition to switching fluorescent lamps according to EN 60 669 standard it can also perform the switching of resistive and inductive loads. (16A-20AX/C-Load).
- Each channel can be controlled manually on the device.
- The following functions can be defined separately for each channel:
 - Stair function
 - External logic
 - Internal logic
 - Priority function
 - Threshold function
 - Transaction time
 - Sweeping function.
- Does not need an external power supply
- The current on/off situations can be arranged by means of ETS parameters.

Dimensions (mm):

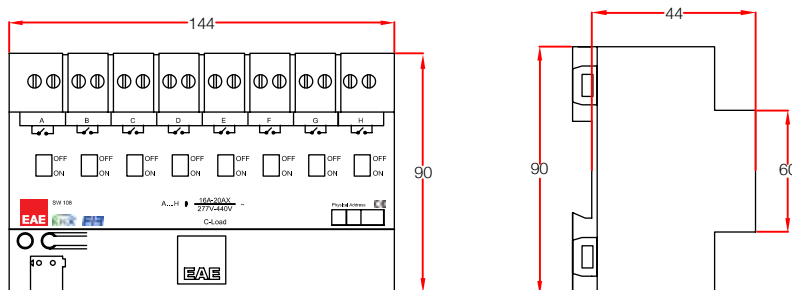

Technical Information

Protection Type	IP 20	EN 60529	
Safety Class	II	EN 61140	
Feed	Voltage range	21 - 30V DC, SELV	
	Current consumption	< 10mA	
Connections	Screw	0,05 - 2,5 mm ² 0,03 - 1,5 mm ² high	
	Maximum Torque	0.8 Nm	
	KNX Terminal	Line Connection	
Output	Number of output units	8 units	
	Switching current	277/440 AC; 50/60 Hz	
	Switching capacity 277 V AC	16A / AC 1	
	Fluorescent Lighting EN 60 699-1	16AX/250 VAC (200µF)	
Relay	Mechanic Life	> 3 x 10 ⁶	
Contact type	Bistable, dry contact		
Configuration	35 mm mounting rail	EN 60 715	
Operating Elements	LED (Red) and button	Used for physical address	
Operating Temperature	Operation	- 5°C +45°C	
	Storage	-25°C +55°C	
	Transportation	-25°C +70°C	
Humidity	Maximum humidity	95% no condensation	
Dimensions	60 x 144 x 89 mm		
Weight	0,45 kg		
Box	Plastic, poly-carbon, gray		
CE	Pursuant to EMC Guide and Low Current Regulation		
Application Program	Communication objects	Max. Group Addresses	Max. no. of matches
	122	253	253

Ordering Information

Product Name	Product Code	Ordering Code	Package Information
EAE Switch Actuator 8x16A	SMP SA108 EAE S-KNX	48002	1 unit

SD110

EAE KNX 0-10V / 1-10V DIM ACTUATOR

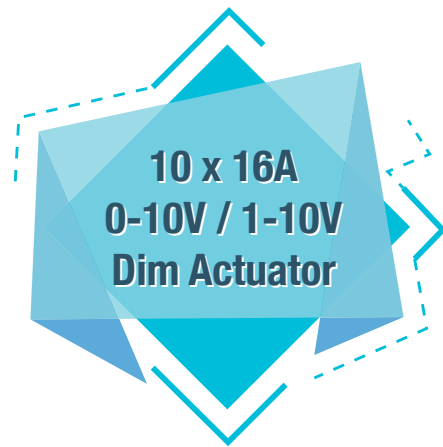

General Specifications

- 10 independent channels that can be parameterized via ETS4/ETS5.
- Manual operation feature for each channel using membrane switches.
- Each channel can actualize any of these functions separately.
 - Following function list provided;
 - Staircase
 - Scene
 - Operating Hour
 - Forced Operation
- Configurable behaviour after voltage return, voltage failure or ETS download.
- Integrated relay on each channel for complete switch off
- Does not require an additional power supply.

Dimensions (mm):

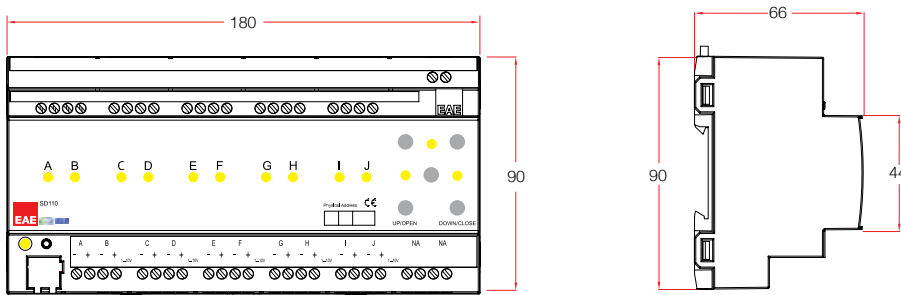

Technical Information

Protection Type	IP 20	EN 60529	
Safety Class	II	EN 61140	
Feed	Voltage range	21 - 30V DC, SELV	
	Current consumption	< 20mA	
Connections	Screw terminals	0,05 - 3,31 mm ² solid and stranded wire 0,05 - 3,31 mm ² stranded wire with ferrule	
	Max tightening torque	0.5 Nm	
	KNX Terminal	Bus connect terminal	
Dim Output	Number	Max 10 Outputs	
	Signal	0...10V DC for dimming control	
	Current Limit	30 mA	
Relay Output	Number	Max 10 Outputs	
	Maximum switching power	4000 VA	
	Mechanical life	> 1 x 10 ⁵	
	Switching current	16A (10 AX)	
	Switching Voltage	250 VAC; 50/60 Hz	
	Switching capacitive load	200µF	
Type of contact	Potential-free, bistable		
Installation	35mm mounting rail	EN 60715	
Operating Elements	LED (red) and button	For physical address	
Temperature range	Ambient	- 5°C +45°C	
	Storage	-25°C +55°C	
Humidity	max. air humidity	95 % no moisture condensation	
Dimensions	Width W in mm	66 x W x 90mm	
	Width W in units (18 mm modules)	180 mm	
Weight	0,4 kg	10 modules	
Box	Plastic, polycarbonate, colour grey		
CE	In accordance with the EMC, LVD and RoHS directives		
Application Program	Communication objects	Number of addresses(max)	Number of assignments(max)
	254	255	255

Ordering Information

Product Name	Product Code	Ordering Code	Package Information
EAE 0-10V / 1-10V Dim Actuator	SMP SD110 EAE S-KNX	48032	1 unit

UD105

EAE KNX UNIVERSAL DIM MODULE



General Specifications

- Incandescent lamp, halogen lamp, dimmable LED and fluorescent lamps can be dimmed up to 1500W in 5 parallel channels.
- Flexibility to connect loads even below 1W (LED bulbs) without any lower limit
- 10 independent channels that can be parameterized via ETS4/ETS5.
- Manual operation feature for each channel using membrane switches.
- Each channel can actualize any of these functions separately.
 - Following function list provided;
 - Staircase
 - Scene
 - Operating Hour
 - Forced Operation
- Configurable behaviour after voltage return, voltage failure or ETS download.

Dimensions (mm):

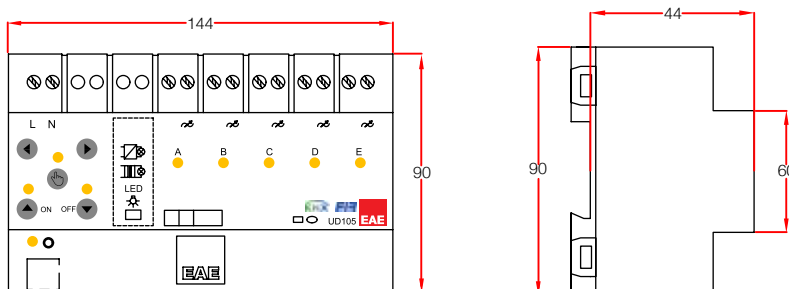

Technical Information

Protection Type	IP 20	EN 60529
Safety Class	II	EN 61140
Feed	Voltage range	21 - 30V DC, SELV
	Current consumption	< 20mA
Connections	Screw terminals	0,05 - 3,31 mm ² solid and stranded wire 0,05 - 3,31 mm ² stranded wire with ferrule
	Max tightening torque	0.78 Nm
	KNX Terminal	Bus connect terminal
Dim Output	Number	5 Outputs (can be used in parallel)
	Voltage Range	0...300VAC; 50/60Hz
	Switching Power	350W / 300VA (1x1500VA)
Type of Load	Incandescent lamps	
	Halogen lamps	
	Inductive transformers	
	Electronic drivers	
	Phase dimmable electronic drivers	
	Dimmable LED lamps	
	Dimmable fluorescent lamps	
Installation	35mm mounting rail	EN 60715
Operating Elements	LED (red) and button	For physical address
Temperature range	Ambient	- 5°C +45°C
	Storage	-25°C +55°C
Humidity	max. air humidity	95 % no moisture condensation
Dimensions		66,5 x W x 89mm
	Width W in mm	144 mm
	Width W in units (18 mm modules)	8 modules
Weight	0,3 kg	
Box	Plastic, polycarbonate, colour grey	
CE	In accordance with the EMC, LVD and RoHS directives	

UI108

EAE KNX-UNIVERSAL INTERFACE

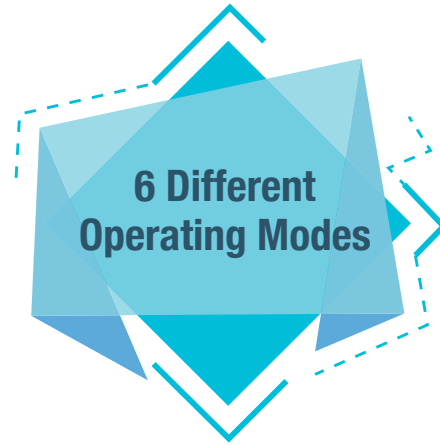

General Specifications

- 8 functional input channels that could be adjusted by means of ETS3/ETS4/ETS5.
- Easy connection with colored connection cables.
- Use by means of conventional switches/buttons upon installation in flush mounted switch boxes.
- Means for including the devices reporting dry contact information, in KNX line.
- The channels are identical with each being in possession of the following functions:
 - Switching
 - Dimming
 - Curtain control
 - Value and priority information relay
 - Scene control
 - Pulse counter

Dimensions (mm)

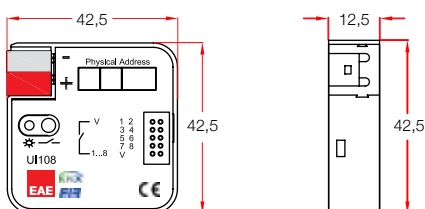

Technical Information

Feed	Voltage range	21 - 30V DC, KNX Line		
	Current consumption	< 10mA		
Inlet	Number of connection points	There are 8 connection points that are used as inlets		
	Permitted cable length	≤ 10 m		
Inlet	Detected Voltage	3.3 V DC		
	Current inflow	0.5 mA		
	Safety	Short circuit protection, over voltage protection, reverse voltage protection		
	Operating Elements	LED (Red) and button	Used for programming the device	
Connections	Inlets	2 x 5 Connector		
	KNX	Line Connection		
Operating Temperature	Operation			
	Storage	-5°C	+45°C	
	Transportation	-25°C	+55°C	
Dimensions	42.5 x 42.5 x 12 mm	-25°C	+70°C	
Weight	0.06 kg			
Box	Plastic, poly-carbon, gray			
CE	Pursuant to EMC Guide and Low Current Regulation			
Application Program	Communication objects	Max. Group Addresses	Max. no. of matches	
	56	254	255	

Ordering Information

Product Name	Product Code	Ordering Code	Package Information
EAE Universal Interface Module – 8 ch.	SMP UI108 EAE S-KNX	48003	1 unit

MIO1616

EAE KNX - MULTI INPUT/OUTPUT

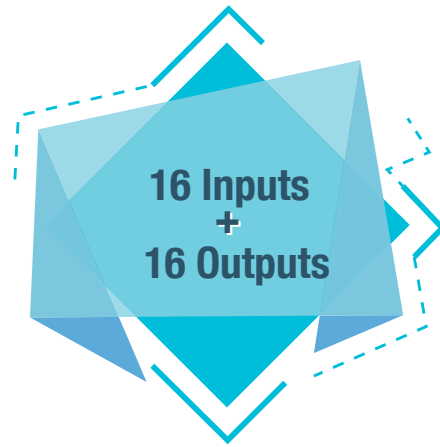

General Specifications

- The KNX Multi Input/output MIO1616 provides multiple connections for push buttons and signal lamps for building functions in one device.
- All channels can be parameterized independently with ETS4/ETS5 or higher version.
- MIO1616 has 16 input channels and 16 output channels
- 16 input channels provide following function list,
 - Switch / push button input
 - Dimmer control
 - Control of shutter/blinds
 - Value
 - Scene control
 - Counter for count pulse
- 16 output channels provide following function list,
 - LED control
- Does not require an external power supply

Dimensions (mm)

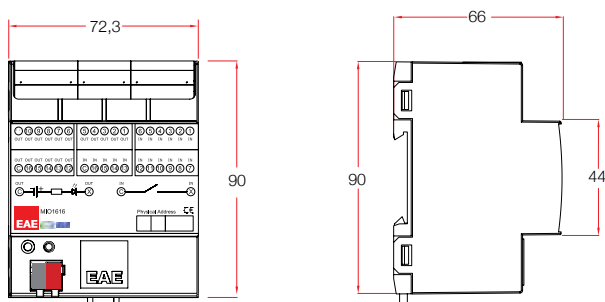

Technical Specifications

Type of protection	IP20	EN 60 529
Safety class	II	EN 61 140
Power supply	- Voltage	21V... 30V DC, KNX hattı ile
	- Current draw from bus voltage	<10 mA
Inputs	- Number	16 giriş
	- Maximum cable length	<10 m
Input	- Scanning voltage	5V DC
	- Input current	0.5 mA
Outputs	- Number	16 çıkış
	- Maximum cable length	<10 m
Output	- Output current	400 mA
	- Load type	Rezistif
Operating elements	- LED (red) and button	Fiziksel adres için
Connections	- Input /Output	
	- KNX	Hat bağlantısı
Temperature range	- Ambient	-5° C + 45° C
	- Storage	-25° C + 55° C
Humidity	- max. air humidity	95 % yoğunlaşma yok
Dimensions		65,5 x G x 89mm
	Width W in (mm)	72 mm
	Width W in units (18 mm modules)	4 modül (18 mm modül)
Weight	0.15 kg	
Box	Plastic, polycarbonate, colour grey	
CE	In accordance with the EMC guideline and low voltage	
Application program	Communications objects	144
	Number of addresses (max)	255
	Number of assignments (max)	255

IPIR100 / IPI100

EAE KNX-IP ROUTER

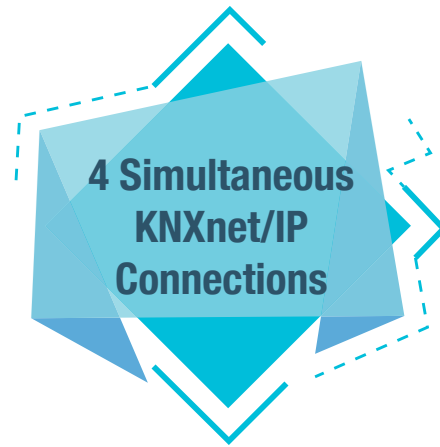

General Specifications (IPIR100)

- EAE KNX IP router may be used as line or backbone coupler and ensures data connection between KNXnet/IP on top and TP KNX bus line at bottom. Moreover it also ensures electrical insulation between the linked lines.
- EAE KNX IP router is a tunneling and routing device. It establishes ETS connection points to start-up and monitor lines with the IP router channeling protocol. (It also possible to simultaneously create 4 KNXnet/IP connections).
- The device makes it possible to connect to two different KNX installations, and ensures the transmission of telegrams between the local network and different lines.
- IP address of the device may be assigned by DHCP server or by manual configuration.
- It can either block or transmit the telegrams between KNX line and IP medium based on the settings in the device filter table.
- It is possible to close without reconfiguring the ETS parameters of filter table for quick diagnosis thanks to the button on the device.
- After the filter of the routing table and filter table ETS configurable time of the device expires, it may be automatically started up.
- The detailed information is shown with 6 LED in order to define the operating status.

Dimensions (mm)

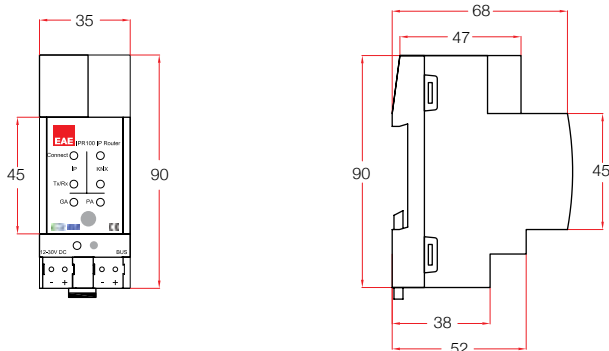

Technical Information (IPR100)

Protection Type	IP 20	EN 60529
Safety Class	II	EN 61140
Power source	Feed voltage	DC 24 V (12V... 30V DC)
	Bus	DC 21...30V SELV
	Current traction through KNX	Type 5 mA
	Current traction	Type 190 mA
	Power consumption	Type 520 mW, max 800 mW
Connections	IP Line	RJ45 socket for 10/100Base T, IEEE 802.3 networks
Screen components	KNX Line	Bus connection terminal
	Power LED	Malfunction LED
	LAN-OK LED	KNX-OK LED
	LAN-RX/TX LED	KNX-RX/TX LED
	Programming mode LED	
Operating components	Function button	
	Programming button	
Installation	35mm DIN rail mounting	EN 60 715 TH 35-75
High Voltage Class	III	IEC 60664-1
Temperature range	Operation	-5 °C + 45 °C no humidity
	Storage	-20 °C + 60 °C
Humidity		5% to 93% no humidity
Measurements	(H x W x D)	90 mm x W x 70 mm
Weight	Width is in W mm	36 mm
Package / Color	Width is in W units (18 mm module)	2 modules
CE	66 g	Installed in 64 mm of depth
	Plastic PA66 / Gray	
Complies with EMC and low voltage rules. The device is compliant with EN 50090-2-2 and IEC 60664-1 a		

Ordering Information

Product Name	Product Code	Ordering Code	Package Information
EAE IPR100 KNX-IP Router	SMP IPR100 EAE S-KNX	48015	1 unit
EAE IPI100 KNX-IP Gateway	SMP IPI100 EAE S-KNX	48016	1 unit

LC100

EAE KNX-LINE COUPLER



General Specifications

- Built-in filter tables for group-oriented communication
- Support of long messages up to 240 bytes APDU length
- ETS4 & ETS5 support
- Galvanic isolation between KNX lines
- Flexibility to be used as line coupler, area coupler or as a backbone coupler
- Does not require an additional power supply

Dimensions (mm)

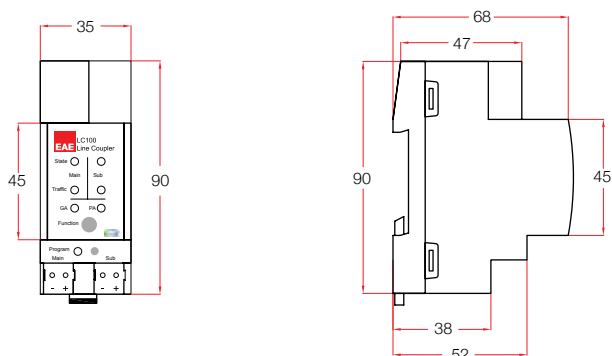

Technical Information

Type of protection	IP 20	EN 60529
Safety class	II	EN 61140
Power supply	Voltage	21V... 30V DC, SELV
	Current consumption	< 30 mA
Connections	KNX Mainline	KNX TP connector (red/black), screwless for single-core cable 0.6..0.8mm
	KNX Subline	KNX TP connector (red/black), screwless for single-core cable 0.6..0.8mm
Installation	35mm mounting rail	EN 60715
Operating elements	Function and Program Buttons	
Temperature range	Ambient	-5° C + 45° C
	Storage	-20° C + 60° C
Humidity	max. air humidity	93 % no moisture condensation
Dimensions	(H x W x D)	94 mm x 36 x 71 mm
	Mounting dept	64 mm
Weight	66 gr.	
Box	Plastic, polycarbonate, colour grey	
CE	In accordance with the EMC, LVD and RoHS directives	

PS320 / PS640

EAE KNX - POWER SUPPLY



General Specifications

- EAE KNX Power Supply is available in 320 mA and 640 mA versions.
- Input voltage range 150-275V AC, 50 60Hz
- Both models have two voltage outputs.
 - Output 1: KNX bus power with an integrated choke. (30VDC, SELV)
 - Output 2: Additional voltage output. (30VDC, SELV)
- Power supply outputs are short-circuit and overload protected.
- Power, Overload and Reset statuses are indicated with three different LED indicators
- Device can be restarted by pressing reset button on the device.

Dimensions (mm)

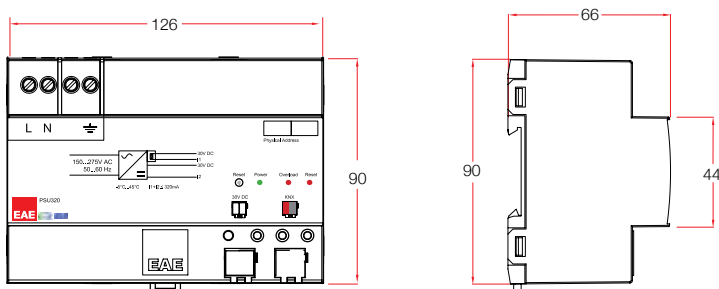

Technical Information

Protection Type	IP 20	EN 60 529
Safety Class	II	EN 61 140
Insulation category	Over voltage category	III EN 60 664-1
	Pollution degree	2 EN 60 664-1
Main Supply	Input voltage	150-275V AC, 50-60Hz
	Power consumption PS320	11,5 W
	Power consumption PS640	22 W
	Power loss PS320	2 W
	Power loss PS640	3,6 W
Output	Output 1	KNX bus 30 VDC +1/-2 V, SELV ((integrated choke)
	Output 2	30 VDC +1/-2 V, SELV (without choke)
	Short-circuit current PS320	1 A
	Short-circuit current PS640	1,5 A
Connections	Screw terminal	0,2 – 5,3 mm ² solid and stranded wire 0,2 – 5,3 mm ² stranded wire with ferrule
	Maximum torque	0.78 Nm
	KNX	Kırmızı-Siyah KNX hattı bağlantısı
Installation	35mm mounting rail	EN 60 715
Operational elements	Power (green)	ON: Input voltage and KNX voltage is OK.
	Overload (red)	ON: Overload or short-circuit.
	Reset button and LED (red)	ON: Reset in progress. Press and hold reset button until the reset LED lights up. No power on KNX bus for 20 s. After reset, rest LED will turn off.
Temperature	Ambient	-5° C + 45° C
	Storage	-25° C + 55° C
Humidity	Max. air humidity	95 % no moisture condensation
Dimensions		60 x W x 90 mm
	Width G (mm)	126 mm
	Width G (unit)	7 module (18 mm module)
Weight	PS320	0.28 kg
	PS640	0,29 kg
Box	Plastic, polycarbonate, colour grey	
CE	In accordance with the EMC guideline and low voltage	

Ordering Information

Product Name	Product Code	Ordering Code	Package Information
EAE KNX Power Supply 640mA	SMP PS640A EAE S-KNX	48023-640	1 unit
EAE KNX Power Supply 320mA	SMP PS320A EAE S-KNX	48023-320	1 unit

CD100

EAE KNX CORRIDOR SENSOR

COMING
SOON



General Specifications

- The CD100 KNX Corridor Sensor is developed for long corridors and car parking spaces. It comes in two models; flush-mounted and surface-mounted.
- Thanks to the integrated light level sensor and movement sensor it can implement fixed light function depending on the presence of a movement. The current level of ambient light is compared to the lux level desired to ensure the appropriate level of illumination in the area concerned.
- By means of the corridor function, different levels of brightness can be arranged for the states of; "Movement", "After Movement", and "No Movement". The duration of light projection after the movement can be adjusted by the user.
- It can operate in parallel connection with other sensors either on standalone or master-slave basis depending on application requirements.
- Based on the state of use of the external controls (button, switch, other sensors, etc.) full or semi automatic operating modes could be set-up.
- Test and calibration modes are convenient during installation.
- Does not need external feed as it receives its feed over KNX line

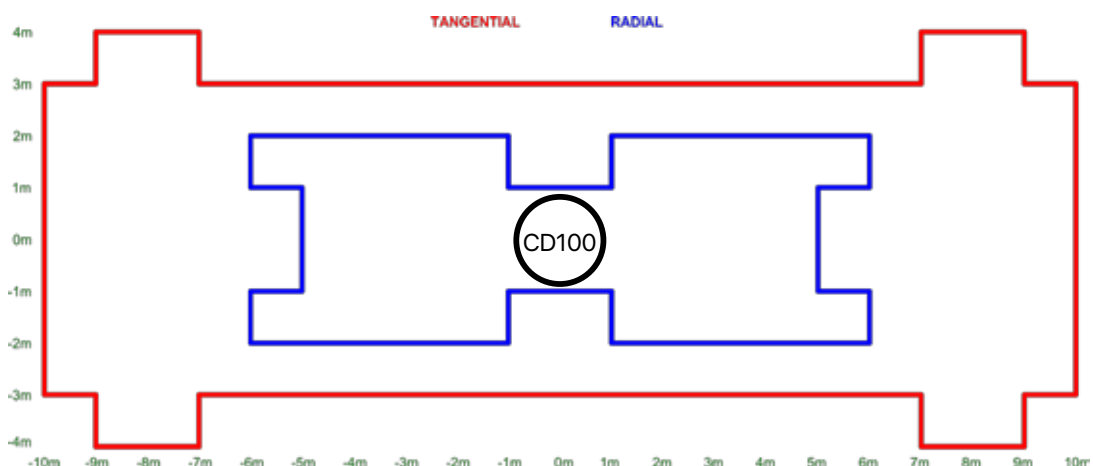

MIG100

EAE KNX-MITSUBISHI CLIMA GATEWAY

COMING
SOON



General Specifications

- Can work together in the presence of other remote controllers, e.g., IR remote controller
- Occupancy and Window/ Door KNX input objects to trigger advanced energy saving profiles
- Control of AC unit functions:
 - Power, mode
 - Setpoint Temperature (with 0.5C precision)
 - Fan Speed (up to 5 including "Quite Mode")
 - Vane Position (up to 5)
 - Wide Vane
 - Remote Lock (with multiple lock types)
- Operating hours counter & alarm
- AC unit error & communication error status objects
- Does not require an additional power supply
- When coupled with a KNX thermostat that monitors ambient temperature: automatic control of AC setpoint temperature to reach the desired setpoint temperature

REFERENCES



**TURKISH AIRLINES
TÜRK HAVA YOLLARI** 
ISTANBUL AIRPORT THY BUILDINGS
Istanbul



TÜRK TELEKOM R&D BUILDING
Istanbul



MERCEDES BENZ TÜRK A.Ş.
Aksaray



DR. LÜTFİ KIRDAR HOSPITAL
Istanbul



TEI MOTORS*
Ankara



TOSÇELİK
Mersin



KAYSERİ SGK
Kayseri



TURK TRAKTOR
Sakarya - Ankara



MARMARA UNIVERSITY
Istanbul



VADİKORU RESIDENCES*
Istanbul



ASYAPORT
Cerkezkoy



KONYA NUMUNE HOSPITAL
Konya



ROUTE ATAKÖY RESIDENCES*
Istanbul



CENTRAL BALAT RESIDENCES
Bursa



AGT AHŞAP
Antalya



PURATOS FOOD INDUSTRY
Belgium



TOP INTERIEUR FURNITURE
Belgium



KOÇTAŞ
Turkey



UNIPRES
U.K.



RENAULT
Bursa



BSH
Cerkezkoy



Kutahya SERAMİK
Kutahya



THY SİMÜLATÖR BİNASI
Istanbul



PEPSICO
Izmir



HIZLI TREN TÜNELLERİ
Ankara-Istanbul



ASAŞ ALÜMİNYUM
Istanbul

NOTES

A series of horizontal dotted lines for taking notes.

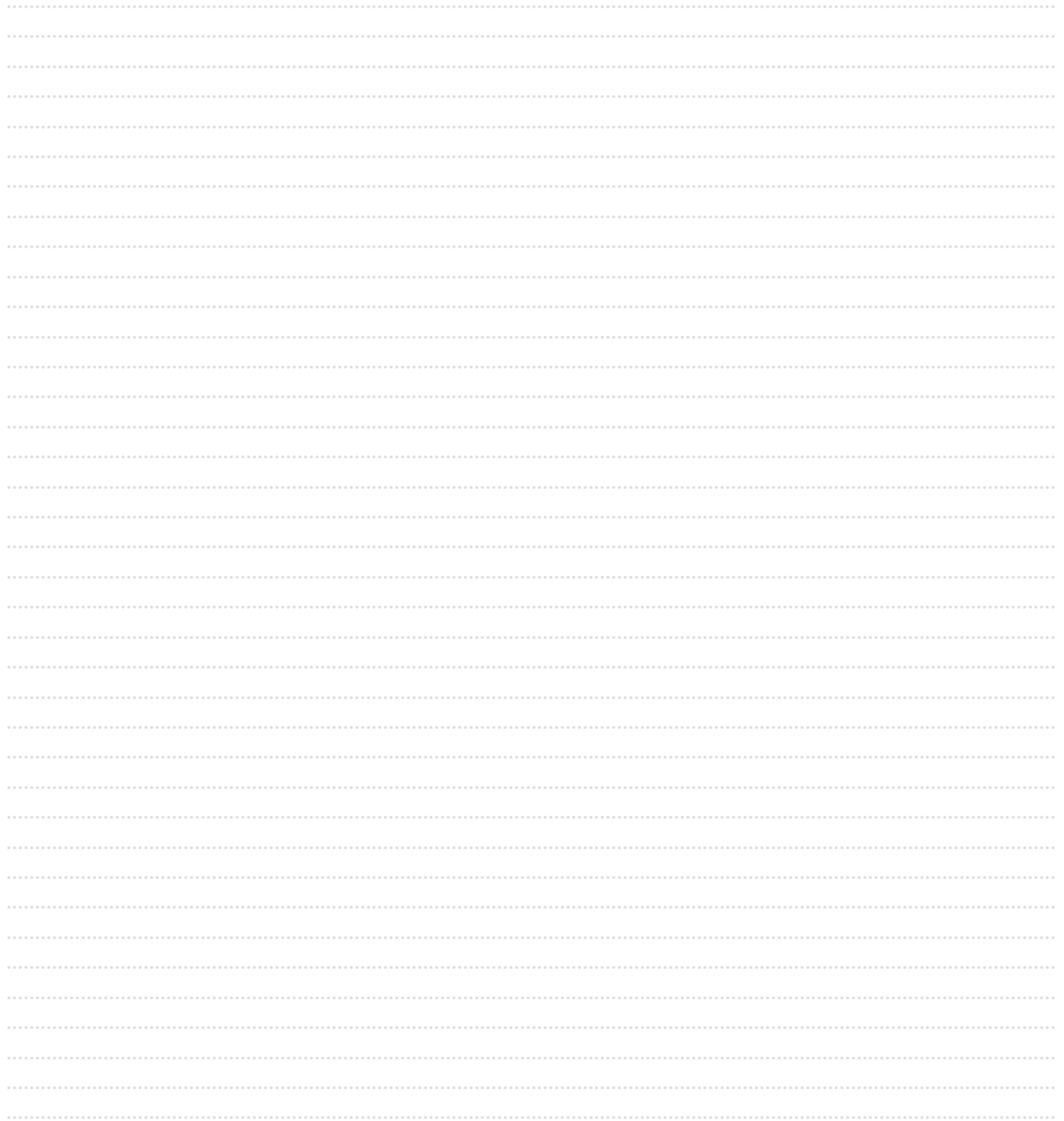

EAE Teknoloji A.Ş.
KNX Industrial and Commercial Building Solutions Product Catalog - 2018

All rights reserved.
EAE Teknoloji A.Ş. reserves the right to make any changes to the contents whenever it deems as necessary.

Please see the technical documents of the relevant device for the installation, connection, and commissioning of the products included in the catalog.

Hyperion II software, logo, software graphics are commercial products and trade dress of EAE Teknoloji A.Ş. They may not be copied or used without permission.

Please contact us for detailed information on products contained in the catalog.



EAE Teknoloji A.Ş.
İkitelli Organize Sanayi Bölgesi
Eski Turgut Ozal Caddesi No:20
Başakşehir / İstanbul - TURKEY
Tel. : +90 212 413 21 00 (pbx)
Fax : +90 212 549 37 90
www.eaetechnology.com



EAE Technology, is provided with the right to perform changes deemed necessary without notifying in advance.
KNX Industrial and Commercial Building Solutions Catalogue English - Issue Date : 26.11.2018